

SRFvh 5501

Laboratory refrigerator with convection cooling

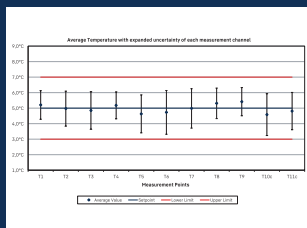

Maximum temperature stability
The dynamic cooling system with double ventilation ensures maximum temperature stability in the interior. Very short defrost cycles allow the interior temperature to be kept almost constant during the defrost phases. All the laboratory appliances are designed for temperature stability and consistency according to EN 60068-3

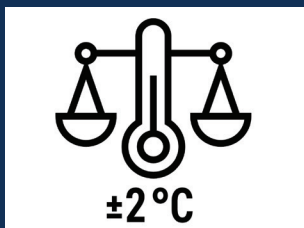

$\pm 2^{\circ}\text{C}$ temperature stability
Temperature fluctuations must be minimal to ensure that the quality of sensitive substances is preserved. Liebherr appliances have an impressive maximum deviation of just $\pm 2^{\circ}\text{C}$ from the set temperature. This not only maintains the storage climate, but also the value of your stored goods.



$+2^{\circ}\text{C}$ SafetyDevice
If the temperature in the appliance drops below $+2^{\circ}\text{C}$ due to a malfunction, the $+2^{\circ}\text{C}$ SafetyDevice function takes control, which keeps the temperature stable and activates an alarm. Sensitive substances are protected from freezing and you are notified immediately.

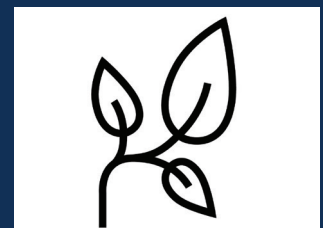

Ultraefficient
Energy-efficient refrigerators and freezers help with ever increasing electricity prices. Liebherr fully utilizes the savings potential of every component – from the compressor to the seal, to the lighting and electronics. The ultra-efficient appliances in the Perfection series for example demonstrates how this has a positive effect on your overall operating costs.

LIEBHERR

SRFvh 5501

Perfection

General purpose refrigerator solid door

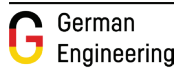

home.liebherr.com



SRFvh 5501	
Total gross/net capacity l (cu.ft.)	558/517 (19.7/18.3)
Exterior dimensions in mm (w/d/h) in inches (w/d/h)	747 / 769 / 1793 29 7/16" / 30 5/16" / 70 5/8"
Interior dimensions in mm (w/d/h) in inches (w/d/h)	600/536/1460 23 7/8"/21 1/8"/57 1/2"
Energy Consumption (kWh/day) *	0.77
EnergyStar rated	Yes
Ambient temperature in °C (°F)	*+10°C to +35°C (+50°F to +95°F)
Heat output	246 kJ/h
Refrigerant	R 600a
Sound rating**	49 dB(A)
Frecuency / Voltage	60 Hz / 115-127V~
Cooling system / Defrost	Forced-air/automatic
Temperature range in °C (°F)	*+3°C to +16°C (+38°F to +60°F)
Gradient / max. fluctuation	2.2 °C / 1.7 °C
External cabinet finish	Steel/white
Door material	Steel
Internal liner material	Commercial grade molded polystyrol
Type of control	2.4" touch & swipe colour display
Power failure alarm	Immediately upon power failure for at least 12hrs.
Fault: warning signal	Visual and audible
Volt-free alarm contact	Yes
Connectivity type	SmartModule
Connectivity solution	Integrated, removable
Interface	WiFi/LAN
Data logger	Integrated, USB interface
Interior light	LED lighting column, left
Adjustable shelves/Shelf material	5 / Wire shelves plastic-coated
Usable Shelf Area in mm (w / d)	606 / 536
Shelf load weight in kg (lbs)	60 kg (132.3)
Castors	Castors with brake at the front, fixed castors at the rear
Handle	Antimicrobial handle with opening mechanism
Access ports	1 x Ø 10 mm
DIN 13277	Yes
Type of lock/Door Hinges	Mechanical/Right, reversible on site
Gross/net weight in kg (lbs)	98 (216) / 89 (196)

Unit Dimensions

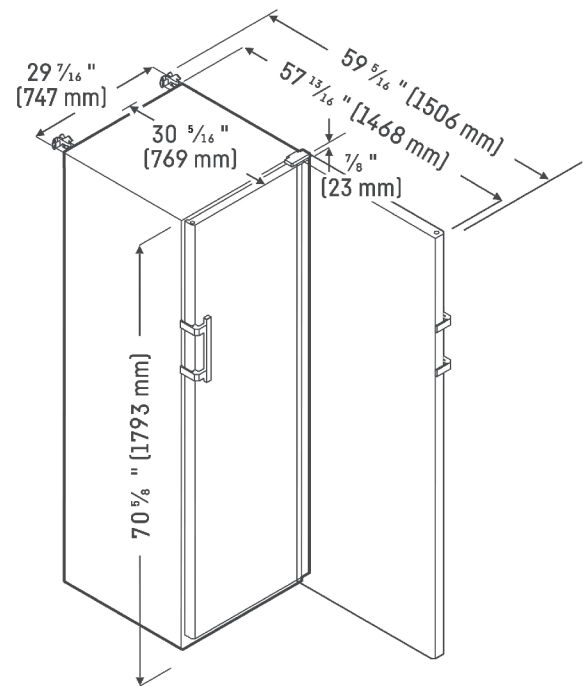

Accessories

Shelf, plastic-coated	7113310
Base grid	7113314
Glass shelf	9291929
Scanner rail	7435210
Castors Ø 80 mm	9086926
Adjustable feet, 90 – 120 mm	9080022
Adjustable feet, 150 – 180 mm	9086924

LIEBHERR

* Measured unloaded at 26.6°C (80°F) ambient temperature with set point of 3.3°C (38°F).

** Noise level – sound power re 1pW – according to IEC 60704-2-14.